

peterson
ORGAPLEX™ SWITCHING SYSTEM
&
OrgaPlex Master Coupler™

Installation and Operating Instructions

© 1999 Peterson Electro-Musical Products, Inc.
11601 S. Mayfield Avenue, Alsip IL 60803-6007
Phone: 1-800-341-3311 FAX: 1-708-388-3367
email@petersonemp.com www.petersonemp.com

peterson

ORGAPLEX™ SWITCHING SYSTEM and OrgaPlex Master Coupler™

INSTALLATION AND SERVICING INSTRUCTIONS

AN OVERVIEW

The OrgaPlex Master Coupler incorporates the circuitry for all couplers that would usually be required on two, three, or four manual instruments into a single "base system" assembly of circuit boards. Couplers may be included in the specification by simply running a wire from the coupler tablet or drawknob to a pre-labelled pin on the Master Coupler Mother Board. The same Master Coupler mother board serves as the console junction for the OrgaPlex system's plug-in main cable, and also as the key junction if Peterson keying cables for OrgaPlex are used. The Main Keyscan Board and one Matrix Division Board per keyboard incorporate scanning and other processing circuitry to "multiplex" information about which key, stop, expression, and other contacts are active at any instant of time and, in effect, sort out what instructions the organist is sending to the organ. The modular design of the OrgaPlex Master Coupler system makes the inclusion of transposer, manual transfer, and MIDI Resource System™ options a simple matter.

A NOTE ABOUT PRODUCT CHANGES

Peterson products, including the OrgaPlex system, are often updated as opportunities for improvement arise. In some cases this is made possible by technological advances, and sometimes changes result from a new feature or application that the existing product does not accommodate. Because of the large number of Peterson control systems in use today and our commitment to offering ongoing support for all the equipment we've ever manufactured, we do everything possible to make sure that new equipment is "backwards compatible" with older systems.

This instruction manual includes a section called "Addendum A" near the end, which includes special mention of recent changes to the OrgaPlex system components. In most cases, the same information is incorporated into the body of the instruction manual, but it is always a good idea to read this addendum and fully understand the changes.

BASIC DESCRIPTION OF MODULES

The Master Coupler Base System is comprised of a Mother Board (#404697); a Main Keyscan Board (#404686) that has all the common clock, scanning and strobe circuits; one Matrix Division Board (#404698) for each division, which includes all of the transposing, transposer wireback, and coupling circuits for that division; and a Line Driver/Junction (#404710) which has line drivers for the main cable. Also, there are optional boards for Rotary and Digital Transposer Selectors and a Manual Transfer feature.

A Coupler/Unit Register Mother Board (#404605) is used for stop unification, switching of straight stops, and/or other special functions by using the following boards: Division All Pitch Registers (#404716) which create 64' thru 1' pitch data; Straight Gates (#404711) which have 8 independent data stop controls; Unit/Coupler Registers (#404606) that include 16'-4' (or 4'-1') pitch registers and data gates, and All Pitch Unit/Coupler Registers (#404667) which are the wide range 16'-1' version of the #404606. The stop control wires to these modules are connected to the tops of each board.

Note: The term "registers" refers to shift registers which are logic devices used to "delay" the serial data stream. These delays are the means of creating various pitches. One could think of these as being like the staggered switches found on old electro-pneumatic switch stacks.

If Peterson is not asked to supply manual keyboards or key contact rails, which would be provided with OrgaPlex-compatible matrixed cables, the OrgaPlex system will usually be provided with DC Key Encoders (#404687 and #404688). The key encoders allow the use of ordinary key wiring, with one wire per key plus the positive key common wire. A 32 Note DC Key Encoder is always provided for the pedal keyboard.

Similarly, DC Stop Encoders may be provided in 48 (#404696) and 61 (#404695) circuit lengths for multiplexing stop, shade, and miscellaneous circuits that must be sent to the chamber.

Mounted independently near the Master Coupler Base System is a Logic Power Supply that supplies regulated 9 Volts DC to all of the assemblies.

At the other end of the OrgaPlex Main Cable, Demultiplexer/ Driver Boards (commonly just called "Demultiplexers" or "DeMux Boards") are provided to convert the multiplexed data back to separate parallel outputs to drive primaries or note actions. The Demultiplexers are usually provided with unpluggable "Output Connector Boards" which are spreaders to which you can lace standard organ cable or phone cable. The Output Connectors provide a simple way to dress the cable at each Demultiplexer while allowing the cable to be unplugged. The part numbers of various Demultiplexers & Output Connectors are shown in Chart 1.

A Chamber Junction (#404677 or 404702, refer to Figure 9) is the "chamber end" termination point for the OrgaPlex Main Cable and includes provisions to distribute data from the main cable to the appropriate Demultiplexers via eight 4-conductor modular cables. The Chamber Junction also includes connection points for Organ Positive and Negative and a data test point. A screw terminal on the Chamber Junction labelled "Control", and a dedicated circuit through the main cable, are provided for sending a DC control signal between console and chamber. This circuit would usually be used to send a DC voltage switched by a power switch on the console, to the relay and contactor in the chamber that controls a blower or rectifier. The Demultiplexers are usually mounted on a panel intended for installation in the chamber or "organ proper", but in certain special cases such as coupler-only OrgaPlex systems, the multiplexing and demultiplexing are both done within the console, and a separate wire for each key is then still used between the console and the chamber.

In other special situations called "Hybrids", an OrgaPlex "Front End" will be used to process console data, but Peterson Diode Matrix Switching equipment will handle any unification and the driving of note actions. In Hybrid systems, the keying data is decoded using special Coupler Demultiplexers designed to plug onto the keying inputs of Diode Matrix Switching Panel Mother Boards.

BASIC DATA/SIGNAL PATHS (refer to figures 5, 5A, 8 & 9)

The key contacts connect to the Matrix Division Boards (via the Master Coupler Mother Board) in a note/octave matrix format. Optionally, parallel D.C. keying can be converted to the note/octave matrix format with D.C. Key Encoders. The note/ octave matrix keying is then converted to a serial format, passes through the transposer/wireback circuitry, which then goes to the pitch registers and finally to the coupler stop gates. The coupler "stop control" contacts also connect to these stop gates (via the Master Coupler Mother Board).

Coupled and/or non-coupled serial data that needs to be unified or switched for straight stops is connected to the division inputs on the Coupler/Unit Register Mother Board(s), which in turn connect to the input(s) of Division All Pitch or Unit/Coupler Register boards. In the case of straight stops, the outputs on the right side of the Division All Pitch board(s) are wired to the inputs on the left side of the Straight Gate board(s). The serial data outputs of these boards are wired to their respective division or rank data lines which then go to the Junction/Line Driver board. The serial data is then fed to the Main Cable (along with clock and strobe signals) to go to the chamber end.

In the organ chamber the Main Cable plugs onto a Chamber Junction board (#404677 or 404702) that connects the serial data, clock, and strobe to modular data cables. These modular cables are used for connection to the Demultiplexers. The Demultiplexers convert the serial data into the parallel D.C. outputs that are wired to the chests.

THE LIGHTED DATA STREAM INDICATORS

A series of Light Emitting Diodes (L.E.D.s) that we call "Lighted Data Stream Indicators" are incorporated on OrgaPlex circuit board modules to allow monitoring the flow of data through the OrgaPlex system. Other important signals such as Strobe and Clock are also monitored. These L.E.D.s and a test wire are normally all that are required for troubleshooting purposes. In OrgaPlex systems manufactured after mid 1998, the L.E.D.s are color coded according to the following pattern: Green indicators are normally on whenever the system is running; Red indicators are generally used to warn of a fault condition and sometimes to indicate that data is present on a board; Yellow indicators may be either on or off under normal circumstances depending on the state of certain controls such as drawknobs and keys. Refer to Figures 4, 5, 5A, and 6 for locations of these indicators.

In normal operation even with no keys depressed, a Master Coupler System should have all the lights on the Main/Keyscan board lit. These lights will appear to be lit all the time. Actually, they are blinking or sequenced at a speed so high that the blinking is not easily detectable. Depressing and holding the "System Slow Down" button on the Main/Keyscan board will slow down the cycle to a speed that makes the sequencing very apparent. On the Master Coupler Mother board, the light labelled "Clock" will appear to flutter on and off and the light labelled "Strobe" will go out when the System Slow Down button is pressed and held. No lights should be illuminated on the Matrix/Division Boards if no keys are pressed or if no stops are on, regardless of whether or not the slowdown button is pressed.

In the System Slow Down mode, the clock (clk) L.E.D. on the Main/Keyscan board will flash at a rate that makes it appear to flutter. The note L.E.D.s will repeatedly sequence in a sweeping fashion, from note "B" through "C". The Octave L.E.D.s will step, in order, from Octave 6 through 1, changing with each sweep of the note L.E.D.s. The Strobe L.E.D. will light when the Octave 1 L.E.D. goes off and will remain lit until the Octave 5 L.E.D. comes on again. Also, the twelve note L.E.D.s will sweep two extra times during the period between the Octave 1 L.E.D. going off and the Octave 6 L.E.D. coming back on.

The L.E.D. labeled "serial" on the Master Coupler Matrix/Division Board #404698 operates as follows: the L.E.D. will be off until one or more keys are depressed. This L.E.D. will then come on and stay on until the key(s) are released. This L.E.D. thus indicates that serial data is present in this board. The L.E.D. labelled "shftd" operates the same way, and indicates the presence of shifted data at the output of the board.

In the System Slow Down mode it can be observed that the "serial" L.E.D. actually comes on when the depressed key is scanned (i.e. with middle "C" depressed, when the Note L.E.D.s sweep through "C" and when the Octave 3 L.E.D. comes on, the "serial" indicator will then light. This light goes off before the Octave 6 L.E.D. comes on again). The L.E.D.s on the OrgaPlex Coupler/Unit Register boards #404606 and All Pitch Unit Register #404666 operate in a similar fashion. However, a stop (or unison) must also be on, before the data is indicated on the output.

The "Lighted Data Stream Indicator" L.E.D. set on Demultiplexer boards has been revised beginning with some versions in mid-1998. Both old and new configurations are described below. The newer Demultiplexer boards are easily identified by the red color of both the bottom and top surfaces of the circuit board. Older version Demultiplexers have a tan colored top surface (component side) and a red bottom surface. More information on revisions to Demultiplexers is available in Appendix A of this manual.

On the older "tan surface" Demultiplexer boards, three Lighted Path L.E.D.s operate as follows (Refer to Figure 4): L.E.D. #1 closest to the treble end indicates input data before it is demultiplexed. L.E.D. #2 near the bass end indicates the data has passed all the way through the Demultiplexer and L.E.D. #3 monitors data half way down the line. (These L.E.D.s do not work in the System Slow Down mode, unless the "Test" terminal on the Demultiplexer/Driver is connected to Organ Positive.)

On the newer "red top" Demultiplexer boards (refer to figure 4), color coded L.E.D.s indicate the status of Data, Strobe, and Clock signals on the board as follows: the Green L.E.D.s for Strobe (STR) and Clock (CLK) will normally be on whenever the system is running, and the yellow Data L.E.D. will be on whenever outputs from the Demultiplexer are being called for. Another yellow L.E.D. labelled "DC" can be used to test for the presence of Organ-Positive-level DC voltages at, for example, the output of a driver chip. To use this L.E.D., simply connect a test lead from the terminal "TP6" to the output pin or other point in question. The presence of a DC voltage will illuminate the L.E.D. A red L.E.D. labelled "Fault" illuminates when any circuit of any UDN2987 Driver IC is in

its protective shut-down state. This occurs when excessive current is drawn through at least one output pin, and may be reset after the shorted coil or other fault is corrected by turning the organ rectifier off and then back on again.

Two totally independent Lighted Data Stream Indicator test L.E.D.s are also provided on OrgaPlex systems. Attaching a test wire to the binding posts for these test L.E.D.s will permit testing at points between boards, on the interconnect cable pins or at the junction boards. One of these test L.E.D.s is located on the OrgaPlex Master Coupler Mother Board (See Figure 6), the other on the Chamber Junction board (See Figure 7), on the chamber panel. These test L.E.D.s will only be illuminated continuously when a circuit carrying a stream of data pulses is completed from a point of interest at Organ Positive potential through the corresponding binding post. When a circuit carrying a DC voltage is completed, the L.E.D. will flash once. In normal operation they will not light.

Note: The brightness of the L.E.D.s on the Matrix/Division, Coupler/Unit Register, All Pitch Unit Register, and Demultiplexer/ Driver boards and independent test points will vary depending on which keys are played. Higher notes will appear to be brighter. If these L.E.D.s do not indicate as described for normal and System Slow Down mode of operation, contact the PETERSON factory for assistance.

INSTALLATION

MOUNTING

Carefully unpack the OrgaPlex Switching System and check for any obvious shipping damage. OrgaPlex Switching Systems are normally supplied with their assemblies mounted on two panels. One panel is the Console or Multiplexing panel as shown in Figures 1 and 2, and the other is the Chamber or Demultiplexer/Driver panel, shown in Figure 7. For coupler-only OrgaPlex systems, the Demultiplexer/Drivers will normally be included on the Peterson Solid State Switching System panel, in the chamber, but might be included on the console panel if traditional cabling is to be employed between the console and the chamber.

The Multiplexing panel is intended to be mounted in the console. The Demultiplexer/Driver panel(s) should be mounted in the organ near the chests they are intended to work.

After identifying the two types of panels, mount the Multiplexing panel in the console, preferably oriented as shown in Figures 1 and 2. Mount the Demultiplexer/Driver panel(s) in the chamber(s). When choosing a location, keep in mind the routing of chest cables and accessibility for ease of working on the system .

WIRING

DEMULTIPLEXER/ DRIVER PANEL

Wire the chest cables to the supplied Output Connector Boards, numbered #406XXX (see Chart 1 for list of driver and output connector numbers) which are plugged onto the Demultiplexer/Driver assemblies. Refer to Figures 4 and 7 and the custom drawing supplied with your OrgaPlex System. The treble end of the Demultiplexer/ Driver is closest to the organ positive and negative terminals and can also be identified by the single-pin or eight-pin connector.

The rank assigned to each Demultiplexer/Driver is labeled adjacent to its printed circuit board with a typed label and can also be identified from the drawing supplied with each OrgaPlex System.

Connect the organ power supply (rectifier) feed wires to the Test and Power Junction #400480, in the polarity as marked. Always use Red for Organ Positive and Black for Organ Negative. The required size of the feed wires can be determined by using the "Organ Power Supply and Feed Wire Worksheet" which is included at the end of these instructions. **NOTES: Reversal of the polarity will cause damage. These should be the first connections made and must be connected before voltage is applied to any other input or output terminals.**

MULTIPLEXING PANEL

KEYBOARDS

When PETERSON Manual Key Contact Rails or Mastertouch Keyboards are used, cables will be supplied that simply plug in. No Organ Positive feed to the key contacts should be added in this case. On Master Coupler Systems the 12 and 8 pin connectors plug onto the Master Coupler Mother Board #404697 (See Figs 3 and 60).

If the OrgaPlex System is being used for an addition to an organ that still requires D.C. keying for the existing keyboards, or if the key common(s) can't be broken into octave busses, D.C. Key Encoders will be provided for positive keying only. Note that a DC Key Encoder is always supplied for the pedal keyboard. Refer to Figure 2 for a typical layout and wiring diagram for this type of system. These D.C. Key Encoders (61 and/or 32 note) will be supplied with a key junction where the key contacts are to be wired. Cables from the D.C. Key Encoders to the OrgaPlex System will be pre-wired and installed. Additional "isolation" diodes are not needed when D.C. Key Encoders are used.

If Peterson modular contacts are not used, and if the use of DC key encoders is not desired, wire the key contacts as follows, referring to Figure 3 for keyboard wiring details. Isolation diodes must be installed in series with each contact. The polarity of these diodes is important. On Master Coupler systems the anode (non-banded end) must be toward the common note bus, the cathode (banded end) toward the individual note contact wires. Diode Board assemblies for 61 notes (#404704) and 32 notes (#404703) may be purchased from PETERSON.

Wire all of the diodes from contacts for the note "C" together and to the "C" terminal on the keyboard junction (See Figure 3), then wire all of the diodes from the C #s together, etc.

The key contact commons must be split into one-octave busses (See Figure 3). The 6 one-octave busses for manuals (or 3 one-octave busses for pedal) then must be wired separately to their respective 8 pin octave connectors on Master Coupler Systems.

CAUTION: THE POLARITY OF THE ISOLATION DIODES IS OPPOSITE in older "Original OrgaPlex" systems compared with all Master Coupler Systems. Be certain to use the proper polarity for your system.

STOP CONTACTS

The stop control contacts (from drawknobs or tablets) should be wired to a Stop Junction such as #404260, #404287, or #400672. This Stop Junction may be provided as part of the OrgaPlex System or Peterson Combination Action, or mounted separately within the console. A pre-wired cable, from the OrgaPlex Coupler/Unit Register boards and/or Master Coupler Mother Board, is supplied that will then plug onto the Stop Junction.

Depending on the organ's specification, Stop Encoder boards are often provided that allow stop, shade, and miscellaneous control wires to be multiplexed and sent through the OrgaPlex Main Cable to Demultiplexer/Driver(s) in the chamber. These are available in 48 and 61 input sizes. Interconnect cables are provided for connection to the OrgaPlex System.

USING SPARE CIRCUITS (refer to Figures 8 & 9)

In smaller organs there may be spare wires in the main cable that can be used for expression shades, tremos, and/or stops to a Pittman chest. There are a total of thirty data conductors in the main cable. One group of eight of these data conductors is always used (via a line driver I.C.) for serial data. This is referred to as the "A Group". Two more groups of eight and one group of six data conductors may have line drivers or may be available as spares. These groups are referred to as the "B Group" (8), "C Group" (8), and "D Group" (6). Any group that does not have a line driver can be used as spares. These groups are identified (and numbered) both on the console Line Driver Junction (#404710) and on the Chamber Junction (#404677 or 404702). Simply match the group and pin number at both ends when using these spares. **Important: never use any main cable conductors for AC**

signals.

Also, when stops are multiplexed, there are usually spares available. The Stop Encoders come in 48 and 61 circuit lengths and are wired on one or more separate junction(s). When there are fewer stops than these sizes, the remaining circuits can be used for spares. Simply wire to the corresponding pins on the stop junction and the stops Demultiplexer. Keep in mind that these must be positive feed and the load's resistance cannot be less than 50 ohms.

Note: The multiplexed spares can only be used for sending data from console to chamber, whereas copper spares can be used in both directions.

A special hard-wire (not multiplexed) "DC control signal" path is provided for connecting a switch in the console via the OrgaPlex main cable to a relay in the chamber for operating a rectifier, blower, or other functions. The voltage carried via this path must be referenced to Organ Negative. In the chamber, the connection point is a screw terminal labelled "Control" on the Chamber Junction board. On Chamber Junctions 404677/ 404702 Version D or later, this circuit is also available on a pin in the "Data/ Spares Group D" connector. This pin is labelled "CNTL". In the console's Master Coupler assembly, this circuit's connection point is on the Junction/Line Driver board (#404710), at a pin of the "D" group labeled "CNTL".

POWER

There are two sources of power for the OrgaPlex System. The Logic Power Supply is a 9 Volt D.C. Regulator Board #404674 mounted on the console panel. Its purpose is to supply a clean, regulated source of D.C. voltage to run the scanning, gating (switching), and Coupler/ Unit Register circuits. Note that blue colored PVC-insulated wire is always used for 9 VDC feeds. The Logic Power Supply may receive its power from a plug-in Class II, 12 VAC, 40VA transformer supplied with the OrgaPlex system. There will be a clear-coated, tagged pair of wires with lugs on the end exiting the wiring duct on the panel. This is to connect to the secondary screws of the transformer which can be plugged into an unswitched outlet (the Regulator Board has its own cut-out relay). If a Peterson Console AC Control System #404444 is used, these wires may be connected to the screw terminals labelled "OrgaPlex 12 VAC" instead of using a separate plug-in transformer. Be sure to read the Console AC Control System's instruction manual for important information about the polarity of this connection.

The OrgaPlex system must also be connected to the organ rectifier. There is a Test and Power Junction #400480 located on the Multiplexing panel in the console. Sometimes, the current capacity of spare conductors in the OrgaPlex Main Cable is sufficient to run the stop feeds and turn on the Regulator Board as well as any other OrgaPlex requirements. If the organ has a combination action, the OrgaPlex cable will not be sufficient to feed power from a rectifier located in the chamber to move the stop actions in the console. The current for moving the stop action magnets must be fed by either an optional PETERSON "Pulse Power Supply" #406275 or a separate organ rectifier in the console, or else through separate feed wires from the main organ rectifier sufficient to operate the stop action magnets. We also recommend separate feed lines for main cables longer than 75 feet. The required size of the feed wires can be determined by using the "Organ Power Supply and Feed Wire Worksheet" which is at the end of these instructions, or contact the PETERSON factory about your specific requirements. If a separate 12-18 Volt console power supply is used to power the console and the stops and shades are multiplexed, no separate feed wires are required.

SPECIAL FEATURES

ROTARY TRANSPOSER SWITCH OPTION

If your system was ordered with the Rotary Transposer Switch Option, it will be equipped with a pre-wired 13 position rotary switch with its associated hardware and engraved plate. The cable provided is 8 feet long. Mount the rotary switch in the desired location in the console. Route the cable to the OrgaPlex console panel. The provided Transposer Stop Control board (#404339) plugs onto pins labeled "Transposer Switch" located on the Master Coupler Mother Board (See Figure 6.) When no transposer is originally installed, these pins have plugged on to them a jumper connector with a wire between pins 1 and 8 in place, to select the neutral "key of C" position. Note: the system must have either the jumper connector (1-8) or the Transposer Stop Control board in place for the OrgaPlex system to operate. This connector also has a blue magnet wire on pin #19 coming from the Unit/ Coupler Mother board for "System Strobe". Remove and discard this jumper connector and transfer the blue wire to pin #19 on the lowest row of wirewrap connectors near the bottom of the Transposer Stop Control

board. Be sure to align the number 1 position on the switch cable's connector to the #1 pin on the Transposer Stop Control board. If you need to add a transposer stop control reversible piston or tab, please contact the factory for assistance. An additional 12 pin connector position near the top of the Transposer Stop Control board is required only when a Peterson MIDI Resource System is connected to the OrgaPlex system.

DIGITAL TRANSPOSER SELECTOR OPTION

The optional Digital Transposer Selector Assembly (#404437) consists of a control panel with "up" and "down" selector buttons and an LED numerical display (#404435), a Transposer Decoder/ Driver circuit board (#404434), and a pre-wired interconnect cable. The circuit board is designed to plug onto the connector pins on the Master Coupler Mother Board (See Figure 6). When no transposer is originally installed, these pins have plugged on to them a jumper connector with a wire between pins 1 and 8 in place, to select the neutral "key of C" position. Note: the system must have either the jumper connector (1-8) or the Transposer Stop Control board in place for the OrgaPlex system to operate. This connector also has a blue magnet wire on pin #19 coming from the Unit/ Coupler Mother board for "System Strobe". Remove and discard this jumper connector and transfer the blue wire to the fourth pin from the left on the 8 pin wirewrap near the bottom of the Transposer Decoder/ Driver board. This pin is labelled "STR" in very small print. On the same connector, a jumper wire must be in place between pin #2 (labelled "STP") and pin #6 (labelled "9V"). Connector positions for one 8 pin and one 1 pin wirewrap connector are provided along the left side of the board for use with the Peterson MIDI Resource System.

After mounting the control panel on the console, simply plug in the circuit board and route the cable neatly. Be sure to line up the first connector socket on the circuit board with the first pin on the Mother Board. If you need to add a transposer stop control reversible piston or tab, please contact the factory for assistance.

TRANSPOSER WIREBACK CIRCUITRY

When the transposer is set to a flat position, it is possible to "run out of pipes" for the lowest notes in the bottom octave. The remedy for this is "wireback circuitry" incorporated within the standard boards on the Master Coupler System. This wireback circuitry will cause the bottom octave at each pitch to "wire back" when transposing flat. For example, playing C1 and transposing flat one step on the switch will play B1. When transposing sharp, notes will automatically carry up into the next higher octave if pipes are present. For example, when a 73 note unit rank playable at 8' and 4' pitches is transposed sharp one step, the top C key of the 8' stop will play pipe #62. The highest note of the 4' stop will be dead because there is no pipe #74.

MANUAL TRANSFER

On organs where a Great/ Choir manual transfer is desired, the optional Manual Transfer Board #404689 plugs onto the Master Coupler Mother Board. Wire the transfer control contact to the labeled pin on that Mother Board. A positive voltage applied to this pin will reverse the Great and Choir manuals. When a Manual Transfer Board is used, two jumpers must be clipped or removed from the Master Coupler Mother Board as described in printing on the Mother Board. ***When these jumpers are removed, the Manual Transfer Board must be in place for proper system operation (See Figure 6).***

MIDI

Provisions for connecting "MIDI" devices has been integrated into Master Coupler Systems. Refer to the PETERSON MIDI Resource System Installation Manual for complete information, or contact the PETERSON factory regarding this specialized feature.

PEDAL COUPLERS AND PEDAL UNISON OFF (refer to figures 11 and 12)

Provisions are included for Pedal Unison Off, Pedal to Pedal 4', and Pedal to Manual 8' couplers. To utilize these special couplers, you must have a Division Matrix board #404697 Version J or higher in the Pedal division position on the Master Coupler Mother board. Beginning with this version, three program jumpers labelled "UO", "PC", and "PJ3" are provided. To enable the special pedal couplers, the "UO" (for Unison Off) and "PC" (For (other Pedal Coupler) positions must be shorted (jumper plugs in place) and the "PJ3" position must be open (jumper plug removed) *on the Division Matrix board for the Pedal division only*. For normal use without these pedal couplers, and for other divisions, only the "PJ3" jumper should be in place.

Note: If these program jumpers are installed improperly on Division Matrix boards for manual divisions, unwanted data and unexpected results may occur on the uncoupled outputs for these manuals.

Activation of these special Pedal couplers and Pedal Unison Off also requires a Master Coupler Mother board of version "F" or later. Tabs or drawknobs to control these couplers are wired to pins on the Mother board as follows:

Program jumpers are provided for selection of which Pedal to Manual couplers are to be substituted for the 16' Great to (the same manual) coupler. When any program jumper labelled "PD-XX" located next to the Division Matrix board for manual division "XX" is in place, a coupler tab or drawknob wired to the "16' Great to XX" input pin on the Mother board will control the "8' Pedal to XX" coupler instead. A Pedal to Pedal 4' coupler tablet may be wired to the unlabelled stop control input pin #2, and a Pedal Unison Off coupler tablet may be wired to the unlabelled stop control input pin #3 (pins 1 and 72 are labelled near the corners of the Master Coupler Mother board).

INITIAL TEST OF THE ORGAPLEX™ SYSTEM AFTER INSTALLATION

PLEASE READ THIS SECTION BEFORE APPLYING ANY POWER!

It is recommended that once you have installed your OrgaPlex System, and have it wired to the chest(s), organ rectifier, and console, you use the following procedure for testing its operation.

- 1.- First remove all Output Connector boards with cables to the chests from their Demultiplexers on the Chamber panel and unplug the Class II Transformer or disconnect the wires from the Console AC Control System's "OrgaPlex 12 VAC" screw terminals in the console. Unplug one end of the OrgaPlex Main Cable from either the Chamber Junction or the Master Coupler Mother Board.
- 2.- Turn on the organ rectifier and check to see that the power light on the "Test and Power Junction" in the console is illuminated. An illuminated power light indicates that a voltage of the proper polarity is applied to the OrgaPlex System. **IF IT DOES NOT LIGHT, REMOVE THE ORGAN POWER IMMEDIATELY**, and confirm the polarity of the connections before proceeding. Lighted Data Stream Indicators on the Demultiplexers may come on during this test. The Troubleshooting section describes the operation of the Lighted Data Stream Indicators.
- 3.- Next, plug the Main Cable back on. Plug in the Class II Transformer or connect the wires to the Console AC Control System's "OrgaPlex 12 VAC" screw terminals in the console and observe the Lighted Path Indicators on OrgaPlex panels in the console and chamber. None of the Demultiplexer lights should be on at this time. The Master Coupler System should have all the lights on the Main/Keyscan board lit. If any other L.E.D.s are illuminated, proceed to the Troubleshooting section.
- 4.- Now test each note (magnet) of each rank or primary by energizing the chest magnets in the following manner. Using a test wire connected to organ positive, apply power to each chest connection on each Output Connector previously removed from the Demultiplexers. Notes which do not play from this point have defects within the chest cable, magnet, chest, pipe, etc. These defects should be repaired before proceeding. The Output Connectors should be plugged back into the Demultiplexers after this test.
- 5.- The OrgaPlex System is now ready to test from the console. Play each note of every stop for all of the manuals. Write a list of any problems that are encountered. This will aid in determining whether the cause is in the keys, stops, couplers, unit stops, etc.

Bear in mind that dead or ciphering notes or stops may be due to contact or wiring defects. These can be confirmed or discounted by unplugging the appropriate key or stop connector from the OrgaPlex System. If the problem is found to be in the OrgaPlex System, repair assistance will be found in the Troubleshooting section.

If you are unable to repair any malfunction with the information provided in this manual, call us at 1-(708) 388-3311 or 1-(800)-341-3311.

ALTERING SPECS/RETROFITTING

ADDING STOPS IN THE CONSOLE (refer to figures 8 & 9)

Most systems currently manufactured which have any unit stops use the Division All Pitch boards (#404716) to create every desired pitch within each division and Straight Gates (#404711) to control data to division and/or rank circuits. In systems that are totally straight, only the Straight Gates are required. Adding stops is nearly identical in either case.

Usually there will be spare circuits in at least one of the Straight Gates. Simply look at the wiring to the connectors on the Straight Gates to see if there is one or more set of pins not used. If there are no available pins, a new Straight Gate can be plugged into any unused position on the Unit/ Coupler Mother Board.

The connector on the left side of the Straight Gate is the division data input. The connector on the top side is the stop control input. The connector on the right side is the division or rank data output. The connector pins on either side correspond (top to bottom) with the pins on the top (left to right). The circuit numbers are printed on the

board. Also see Figure 10, Detail "A".

Connect the unused input pin (on the left side of a Straight Gate) to the desired pitch of the Division All Pitch board for the division that the stop speaks in. The pitch outputs are on the right side of the Division All Pitch board and are clearly labelled (See Figure 10, Detail "B"). Connect the stop control to the respective pin on the top of the Straight Gate. Connect the respective output pin on the right side of the Straight Gate to the desired division or rank circuit. These can best be identified by referring to the blueprint Wiring Chart supplied with each system. If the wiring chart is not available, wedge on a key and turn on a stop for the desired rank. Then use a test wire connected to the "Test Binding Post" and probe the output pins of the Straight Gates. When the "Test Light" comes on and stays on, you have located the pin with continuous data present. This is the one to which you should make your connection. In the case of a totally new rank, see the next section.

ADDING A SERIAL DATA CIRCUIT TO THE MAIN CABLE (refer to figures 8 & 9)

In the case of a totally new rank, it is necessary to add a data circuit to the main cable. Usually there will be spare conductors available to send data through a Line Driver and the main cable. Look at the connectors on the top of the Line Driver Junction board (#404710) in the connector groups that have the line driver I.C.s to see if there are any pins that are not wired. Note: If no pins are available, a Line Driver Expander module (#404675) must be plugged onto a Line Driver connector in the console and a Modular Expander assembly (#404678) must be plugged onto the corresponding section of the Chamber Junction. This pair of optional circuit boards gives extra capacity for sending multiplexed data through the main cable.

Connect a wire from the output of the added Straight Gate to the available line driver. Note which group (A-D) and pin number (1-8) is being used. Groups A, B, and C have eight pins each while group D has only six. A Demultiplexer must then be added for this new rank at the other end of the main cable, as explained in the next section.

ADDING DEMULTIPLEXER(S) (refer to Figures 8 & 9)

Find a suitable location near the other Demultiplexer/ Drivers on the Chamber Panel and mount the new Demultiplexer/ Driver. Wire the chest to its Output Connector board. The lowest note is farthest from the modular jack and power connections. Connect the organ rectifier's positive and negative polarities to the two screw barrier terminal on the Demultiplexer/Driver. Observe the polarity carefully when making these connections. Preferably, the source/ feed for these wires should be the Chamber Junction. Use red wire for Organ Positive and black wire for Organ Negative.

Next plug one end of the new Modular Data Cable into the Demultiplexer's modular jack. (Modular Data Cables are standard four wire telephone modular cables.) The other end of the Modular Data Cable plugs into the jack at the Chamber Junction for the corresponding Group/ Pin Number that was connected in the Console.

Finally, a strobe wire must be connected from the Strobe Connector (near the modular jacks on the Chamber Junction) to the pin that corresponds with the desired modular jack. **Important: Never touch any two different strobe pins or wires together or damage may result.** Strobes "A-G" and "N" are available and the easiest means of determining the proper strobe would be to use a test lead to temporarily connect the "D" Strobe and test the Demultiplexer to see if it plays at its correct pitch. If not, simply move the test lead to another strobe pin that causes the stop to play at the proper pitch. After turning the power off, a permanent wire can then be connected. (Also refer to the following section: "Re-Pitching via Strobe"). Follow the "Initial Test" section when the added Demultiplexer is ready for testing.

RE-PITCHING VIA STROBE (refer to Figures 8 & 9)

The pitch of each Demultiplexer is determined and pre-wired during manufacturing. However, there may be occasions when it is desirable to change the pitch of a stop, such as when extending an existing rank with a longer Demultiplexer. In these cases it is a very easy procedure to change the pitch of the entire stop by moving the strobe wire for that stop. These strobe connections are located on the Chamber Junction near the modular data jacks.

The jack number can be identified by the letter/number tag on either end of the modular data cables. The correct one can also be verified by unplugging the cable to be sure the stop of interest goes dead. Having determined

the jack number, the strobe connector pin for that jack is labeled (numbered) respectively.

With the power off, unsolder and remove the wire from this pin. It is best not to clip the wire as often times the wire will loop through to another pin. The strobe letter (A-G) that was being used can be determined by using an ohm meter to test for continuity at each of the strobe connector pins. Now connect a test lead between the pin from which the strobe wire was removed and an adjacent strobe pin (A-G). Moving closer to "A" will raise the pitch and moving closer to "G" will lower the pitch. After testing the Demultiplexer to be sure it is playing the pipes at the proper pitch, make permanent connections for this wire. The old wire should be shortened to its nearest connected pin or, if this is impractical, then taped to prevent it from accidentally shorting.

Notes: 1. Keep in mind that changing the strobe selection may result in less than enough pipes being playable from the keyboard. 2. The Strobe Connector pin labeled "N" is only used for Demultiplexers that handle stops, shades, and miscellaneous spare circuits. Do not use it for speaking stops.

TROUBLESHOOTING

USE OF THE LIGHTED DATA STREAM INDICATORS

If a problem occurs, it should be easy to isolate with the Lighted Path Indicator L.E.D.s. The following examples show the proper method to use in finding problems.

Example 1: If the unit flute rank (such as #4 in Figure 5) is dead on all manuals on which it plays and any fuses are verified to be good, turn on one of the stop controls (Swell 8') for that rank and hold a key (Swell middle C) down. Check the L.E.D.s on the Demultiplexer/Driver for that rank. If the appropriate L.E.D.s are on, check to be sure the chest plays by keying the output with organ positive. If the chest plays try "swapping" the Demultiplexer with one that is known to work, or moving modular (phone) cables as described in the following section on Swapping . If the Data L.E.D.(s) (and Clock and Strobe L.E.D.s if included) are not on, the problem may be in the modular cable (Figure 4) going to the unit flute Demultiplexer/Driver (Figure 5, #4).

If swapping Demultiplexers or modular cables does not correct the problem, return to the console and with a test wire connected to the test binding post on the Master Coupler Mother Board, touch the test wire to data pin A4 (see Figure 6.) If the test light comes on and stays on, the problem is likely in the line driver I.C. or the main cable.

If the test light does stay on and the Lighted Path L.E.D.s are lighted on the Unit Register board for the flute, the problem is likely in the wiring between the Unit/ Coupler mother board and the Master Coupler Mother Board.

Example 2: The unit flute rank plays from the pedal but not the swell (the swell primary does play). Turn a stop and key on (as in Example 1). Check the Lighted Path Indicator L.E.D.s on the OrgaPlex panel in the console for the Swell unit flute (Coupler/ Unit Register board #404606 or All Pitch board #404666). If the test L.E.D. doesn't light in response to the Coupler/ Unit Register output data, try swapping the Coupler/ Unit Register (or All Pitch) board with a known good one of the same type.

More on troubleshooting for a specific problem will be covered in the "Troubleshooting Guide" section later in this manual.

SWAPPING BOARDS

When swapping boards (trading a known good board for a suspect board) the organ power and 12 VAC to the OrgaPlex should be turned off. Damage might result if a board were plugged in incorrectly when the power is on.

When swapping Demultiplexer boards for diagnostic purposes it is not necessary to substitute one that has the same number of notes. For example, a 61 note or 85 note board may be used in place of a 73 note board (the low note #1 will always be in the same position).

Also, it is usually easiest to unplug and shift the data cables of adjacent Demultiplexers rather than moving the whole board when swapping is called for. If the rank connected to the output of the "new" Demultiplexer board now plays from the suspect board's stops, the original Demultiplexer board is likely to be defective. To verify this,

switch the output cables (chest cables) and see if the proper rank now plays.

CHECKING ZENER DIODE "ZD1" ON DEMULTIPLEXER/DRIVER BOARDS

Note: ZD1 is used for voltage stabilizing purposes in "tan surface" Demultiplexers, but it is replaced by voltage regulator U3 on "red surface" Demultiplexers (See Addendum A). Consequently, this section only applies to OrgaPlex systems that have at least one "tan surface" Demultiplexer.

When problems are encountered with an OrgaPlex system, it is useful to check the 9 Volt Zener Diode on each Demultiplexer/Driver Board. These diodes will fail when Organ Positive comes in contact with 9 Volt AC circuits within the OrgaPlex system, such as may happen when a clip lead is accidentally touched to certain parts of the circuit boards. To check a Zener Diode ZD1, use a meter set to read D.C. Volts. Carefully put the positive (red) meter lead on the diode's lead at the banded end, and the negative (black) meter lead at the end of the diode that is not banded. With the OrgaPlex System power on, approximately 9 Volts should be read. A much lower voltage indicates that the diode is shorted and must be replaced. A much higher voltage indicates that the diode is open and must be replaced. Be sure to turn off all power before removing the Demultiplexer/ Driver Board for servicing.

CHECKING DRIVER I.C.s WHEN DEMULTIPLEXER FUSE BLOWS WITH NO NOTES PLAYED AND CABLE UNPLUGGED

Note: As explained in Addendum A, "red surface" Demultiplexers use #UDN2987 driver I.C.s which feature an automatic shutdown to prevent damage when an overcurrent condition such as a shorted or low resistance magnet coil is present on an output. Whenever a 2987 is latched in its shutdown state, the Demultiplexer's red LED labelled "Fault" will come on. After repairing the fault, full operation can be restored by switching the organ's power off and back on. While unlikely, it is still possible for 2987 chips to be damaged by an overvoltage condition such as a direct or severe nearby lightning strike.

A simple way to test whether defective driver I.C.s #UDN2982 are the cause of blown fuses is to use an automotive turn signal or other high current light bulb across the fuse clips instead of the fuse. After having the power on for about 5 minutes, any defective driver I.C.s will get warm or hot to the touch. Be sure to turn off all power before replacing any I.C.s.

TROUBLESHOOTING GUIDE

SYMPTOM	PROBABLE CAUSE	HOW TO ISOLATE
ENTIRE ORGAN DEAD		
A. - No indicator lights on, on any of the console boards.	1. No 110 VAC power to OrgaPlex transformer or Console AC Control.	Check fuses, circuit breakers, line cords, etc., for 110 VAC circuits.
	2. Loss of organ rectifier DC power to Logic Power Supply #404674.	Use Voltmeter to check for 11 - 18 VDC.
	3. Loss of 9 VDC Logic Supply (or 12 VAC from Class II transformer or Console A.C. Control System.	Use Voltmeter to test for 9 VDC or 12 VAC.
B. - Proper indicator lights are on in console or OrgaPlex boards	1. Chamber clock fuse blown.	If indicator light next to fuse (on Master Coupler Mother board near main cable connector) is on, replace the fuse.
	2. Clock driver transistor Q4 on Main Keyscan #404686 is blown.	With its fuse removed, temporarily connect test lead from Clock fuse clip (on Master Coupler mother near main cable socket; use clip nearest Keyscan board) to clock ("CLK") terminal of the local data connector (lower right corner). See Fig. 6.
INDIVIDUAL NOTES DEAD		
A. One note key of manual is dead on all stops or couplers.	1. Key contact defective or not making.	Using a test wire connected to TP9 (binding post) on Master Coupler mother, trace the multiplex signal path by testing at TPH (see Figure 3) octave common, then TPG, TPF, TPE and TPD to determine where the signal is lost.
	2. Connector or wiring to key contact open.	
	3. Defective diode on isolation board.	
B. One note of a unit rank is dead and not playable from any stops of that rank.	1. Chest or pipe defective.	Test the chest and junctions by using a test wire from organ positive to "key" the chest. Keep in mind the 1-2 Volt drop within the relay. Does the note action work on less than full rectifier voltage?
	2. Output connector or wire not "making".	
	3. Output driver I.C. UDN2982 or 2987 defective.	With the organ power off, carefully remove and exchange the suspected I.C. with a known good one from another position. NOTE: Be sure the chest is working before suspecting an I.C.
	4. I.C. CD4094 is defective.	
	5. UDN2987 Driver in protective "Shut Down" mode after overcurrent condition was detected.	

SYMPTOM	PROBABLE CAUSE	HOW TO ISOLATE
C. All of the same kind of note is dead (i.e. all "C" keys).	1. Keyboard junction wiring or connector open (if only one keyboard is affected).	Using a test wire connected to TP9 (binding post) on Master Coupler Mother, trace the multiplex signal path by testing at TPD (see Figure 3) then TPC, TPB and TPA to determine when the signal is lost.
	2. Main/Keyscan #404686 defective (if all keyboards).	
D. One half of all octaves of keyboards are dead.	1. Main/Keyscan #404686 has bad IC #U9 or U10.	With the organ power off, carefully remove and exchange the suspected I.C. with a known good one from another position.
E. One entire octave of a keyboard is dead.	1. Wiring from keyswitch octave common is open.	Using a test wire connected to TP9 (binding post) on Master Coupler mother, trace the multiplex signal path by testing at TPH (see Figure 3) then TPI and TPJ to determine where the signal is lost
	2. Matrix / Division board #404698 is defective.	With the organ power off, carefully remove and exchange the suspected board with a known good one.
ENTIRE STOPS DEAD		
A. One stop of a unit rank or coupler is dead.	1. Stop contact or wiring.	Using a test wire connected to TP9 (binding post) on Master Coupler mother, check to see if voltage is present at connector on Coupler/Unit Register #404606 (see Figure 1, Detail A).
	2. Coupler / Unit Register board defective.	With organ power off, carefully remove and exchange the suspected Coupler/Unit Register with a known good one.
	3. Straight Gate Board defective (#404711)	Stop input LED of interest should come on when the stop control is activated causing a voltage to be applied to the pin. If it does but the stop doesn't play, exchange suspected Straight Gate with a known good one.
	4. Matrix / Division board defective.	With organ power off, carefully remove and exchange Matrix / Division with a known good one.
B. All stops of a unit rank are dead.	1. Chest	Test the chest by using a "hot" wire from organ positive to key the chest.
	2. Demultiplexer / Driver fuse open.	Test fuse with a meter and replace if necessary.
	3. Modular Data Cable or junction open.	Using a test wire connected to TP9 (binding post) on Chamber Junction, trace the multiplex signal path by testing at TPQ (see Fig. 7) and TP5 or TP6 (on Demultiplexer) to determine where the signal is lost.

SYMPTOM	PROBABLE CAUSE	HOW TO ISOLATE
----------------	-----------------------	-----------------------

B. One note of a unit rank is dead on all stops or couplers, cont'd.	4. Coupler / Unit Register board #404606 is defective.	With organ power off, carefully remove and exchange the suspected Coupler/Unit Register with a known good one.
C. All stops of the same pitch in one division are dead.	1. Division All Pitch board defective (#404716).	With organ power off, carefully remove and exchange the suspected Division All Pitch with a known good one.
D. 16' Coupler Dead	Program jumper PJ3 open on Division Matrix Version J or later.	Put a program jumper plug on to the pins in position PJ3
NOTES PLAY WHEN THEY SHOULD NOT		
A. One note of a rank ciphers with no stops and no keys depressed.	1. Chest magnet or a primary stuck.	Unplug the output connector from the rank in question, if the cipher continues the problem is in the chest.
	2. Output driver I.C. UDN2982 or 2987 defective or CD4094 I.C. is defective.	With the organ power off, carefully remove and exchange the suspected I.C. with a known good one from another position.
B. A single adjacent note "runs".	1. Short in chest cable wiring.	Unplug the output connector from the Demultiplexer in question and "key" the chest with a wire from Organ Positive. If the "run" occurs the problems is in the chest or cable.
	2. Output driver I.C. UDN2982 or 2987 is defective.	With the organ power off, carefully remove and exchange the suspected I.C. with a known good one.
C. Adjacent notes of a rank run, chatter, or jitter.	1. Logic Power Supply board is defective (#404674).	Output voltage should measure 8.5 to 9.0 Volts. Replace with a known good one.
	2. Demultiplexer / Driver is defective.	With the organ power off, unplug the data cable from the suspected Demultiplexer and plug it into an adjacent Demultiplexer. If the run clears the Demultiplexer if defective.
STOPS PLAY WHEN THEY SHOULD NOT		
A. One stop cannot be turned off.	1. Stop contact always closed or short in wiring.	Unplug the stop connector from its Coupler/Unit Reg. #404606 (See Figure 1). If the problem clears check the contact and wiring.
	2. Problem in combination action, or MIDI.	Unplug the stop (sense) connector from the combination action or MIDI to isolate.
	3. Coupler/Unit Register board (#404606) is defective.	With the organ power off, carefully remove and exchange the suspected Coupler/Unit Register board with a known good one.
SYMPTOM	PROBABLE CAUSE	HOW TO ISOLATE

A. One stop cannot be turned off, cont'd.	4. Straight Gate Board (#404711) defective.	With organ off, carefully remove and exchange the suspected Straight Gate Board with a known good one.
UNUSUAL PROBLEMS		
A. Any one or two notes of a rank will play. But, any 3rd (or 4th) note added kills all the notes of that rank.	Demultiplexer/ Driver fuse open.	Test fuse with a meter (or replace) on the Demultiplexer for the rank in question.
UNUSUAL PROBLEMS CONTINUED		
B. A rank plays one or more octaves off pitch (i.e. 8' stop sounds 4').	Strobe connected to wrong terminal.	On the strobe select wiring (see Figure 7, Detail B) remove the strobe wire for the rank involved and reconnect to an adjacent strobe (retest before soldering).
	Incorrect wiring from Demultiplexer to chest.	Verify that the chest is wired to the intended pins. Sometimes the provided Demux is longer than the number of notes on the chest to provide for borrows, an electronic extension, or resultant wiring by the installer.
C. L.E.D.s come on but do not go off.	Strobe open.	Using a test wire connected to TP9 (binding post) test for strobe at power connector of Coupler/Unit mother or TP6 on Demultiplexers.
D. Notes stutter or intermittently transpose.	1. Cable too long or picking up interference.	May require additional rectifier feeds to console. Visually inspect to be sure all shields are properly connected.
	2. Logic Power Supply board #404674 defective or regulator not bolted tight enough to the heat sink.	With organ power off, carefully remove and exchange the suspected regulator board with a known good one if necessary after trying to tighten screws.
	3. Demultiplexer defective.	With organ power off, unplug the data cable from the suspected Demultiplexer and plug it into adjacent Demultiplexer. If the problem clears, the Demultiplexer is defective.
E. Uncoupled data dead whenever 16' Swell to "XX" coupler is on.	Program jumper installed in the "UO" position of manual division "XX"'s Division Matrix Board.	Remove program jumper from "UO" position on "XX" Div/Matrix.
F. Pedal plays at suboctave pitch when 16' Solo to Pedal coupler is on.	Program jumper installed in the "PC" position of the Pedal division's Division Matrix Board.	Remove program jumper from "PC" position of the Pedal's Div/Matrix.
G. 4' data plays on "XX" manual division's uncoupled output when Solo to "XX" coupler is on.	Program jumper installed in the "PC" position of the "XX" manual division's Division Matrix board.	Remove program jumper from "PC" position of the division's Div/Matrix.

The preceding guide should enable any organ service person, regardless of familiarity with electronics, to repair nearly any trouble in the OrgaPlex System that may develop. If a problem does arise which the technician is

unable to correct, the modular construction of PETERSON systems permits the troublesome part to be isolated by simply unplugging the suspected module and swapping it with one known to be good. If the problem moves with the module, that module is defective. If further assistance is required, call 1(708)388-3311 or toll free from anywhere in the United States or Canada 1 (800)341-3311. **A simple phone call may save much time and money.**

CHART 1			
AVAILABLE DEMULTIPLEXERS AND OUTPUT BOARDS			
		DEMULTIPLEXER	OUTPUT BOARD
SIZE	TYPE	PART NUMBER	PART NUMBER
109	UNIT	404620	406000
97	UNIT	404619	406009
85	UNIT	404618	406008
73	UNIT	404617	406007
61	UNIT	404611	406006
49	UNIT	404614	406005
32	UNIT	404613	406003
13	UNIT	404631	406011
73	CPLR	404627	NA
61	CPLR	404623	NA
49	CPLR	404718	NA
32	CPLR	404622	NA
24	H. D.	404713	406002

- NOTES: 1. Unit type: Used for Unit and/or Straight Ranks, Stops, Expression motors, and miscellaneous.
2. Cplr type: The output is an edge connector that can be plugged into a multi-row junction or Diode Matrix Mother Board for use in hybrid systems.
3. H. D. type: Heavy Duty (1 -12 = 6 Ohm, 13 - 24 = 20 Ohm) Output

ADDENDUM A

Recent OrgaPlex Updates

DEMULTIPLEXER IMPROVEMENTS (Refer to Figure 4)

Demultiplexer/ Driver boards have been updated beginning in mid-1998. Several improvements have been incorporated into these boards. The most noticeable change is that the newer generation boards are red in color on both sides and have circuit traces visible on the top surface. Switching to "double sided" boards allows them to be slightly more compact. A significant functional change is that the new version boards use a UDN2987 Driver IC in place of the formerly used UDN2982. The 2987 has the same power dissipation ratings but includes an automatic protective shutdown feature. If a load on one of the outputs to the chip such as a shorted magnet coil draws too much current, that particular output is instantly turned off to prevent the chip from being damaged. The circuit may be reset after correcting the fault by turning the organ rectifier off and then back on. A red LED labelled "Fault" illuminates when the chip is in its shut-down state as an aid in identifying the problem. Other color coded LEDs on the board now indicate the status of Data, Strobe, and Clock signals on the board as follows: the Green LEDs for Strobe and Clock will normally be on whenever the system is running, and the yellow Data LED will be on whenever outputs from the Demultiplexer are being called for. Other changes to the Demultiplexer include an improved voltage regulator on each board which eliminates the need for Zener Diode "ZD1", and a more rigidly mounted terminal block for connecting Organ Positive and Negative.

DIVISION MATRIX CHANGES (Refer to Figure 11)

Beginning with Version J, the Division Matrix boards now use 5 Volt logic. A 5 Volt regulator is included on each board, and 74HC family I.C.s are used in some positions. Provisions have also been added for Pedal Unison Off, Pedal to Pedal 4', and Pedal to Manual 8' couplers. Three new plug-in program jumpers have been added to facilitate the special couplers. When the Division Matrix board is used for any manual division or for a pedal division where these special couplers are not required, only a program jumper labelled "PJ3" should be in place. To enable the Pedal Unison Off coupler, remove jumper "PJ3" and add a program jumper in the position labelled "UO". To enable the Pedal to Pedal 4' and Pedal to Manual 8' couplers, remove jumper "PJ3" and add a program jumper in the position labelled "PC". Pedal coupler stop controls are then wired to the Master Coupler mother board as explained below.

MASTER COUPLER MOTHER BOARD CHANGES (Refer to Figure 12)

On Version F Mother boards, several changes were made. A separate MIDI Option Interface board, formerly required with using a Peterson MIDI Resource System, is no longer needed because its circuitry is now built into the Master Coupler Mother board. Plug-on program jumpers are now used in place of soldered wire jumpers for selecting or bypassing the Manual Transfer option: the jumpers labelled J3 and J4 must be in place when no Manual Transfer board is installed, and they must be removed when a Manual Transfer board is installed. Program jumpers are also provided for selection of which Pedal to Manual couplers are to be substituted for the 16' Great to (the same manual) coupler. When any program jumper labelled "PD-XX" located next to the Division Matrix board for manual division "XX" is in place, a coupler tab or drawknob wired to the "16' Great to XX" input pin on the Mother board will control the "8' Pedal to XX" coupler instead. A Pedal to Pedal 4' coupler tablet may be wired to the unlabelled stop control input pin #2, and a Pedal Unison Off coupler tablet may be wired to the unlabelled stop control input pin #3 (pins 1 and 72 are labelled near the corners of the Master Coupler Mother board). Shorting stop control input pin # 72 to Organ Positive with a switch or wire turns all MIDI couplers on.

IMPORTANT: Prior to February, 2000, installers were instructed to connect pins #72 and 71 together to enable all MIDI couplers. Pin #71 is a source of "+9 Volts". We now recommend connecting pin #72 to Organ + for this purpose. It is imperative that pin #71 be disconnected from #72 first!

Note: the special pedal coupler functions incorporated into this Mother board are only usable with a properly configured Division Matrix board as explained in the section above.

FILE: D:\WP51\FILES\INS\MCORGNEW.INS REV. 1/99 and 2/00
© 1994,1996, 1999 P.E.M.P.,Inc.
Printed February 19, 2002

CLASS II TRANSFORMER
OR CONSOLE AC CONTROL SYSTEM

STOP CABLE TO COMBINATION ACTION

MULTIPLEXING (CONSOLE) PANEL

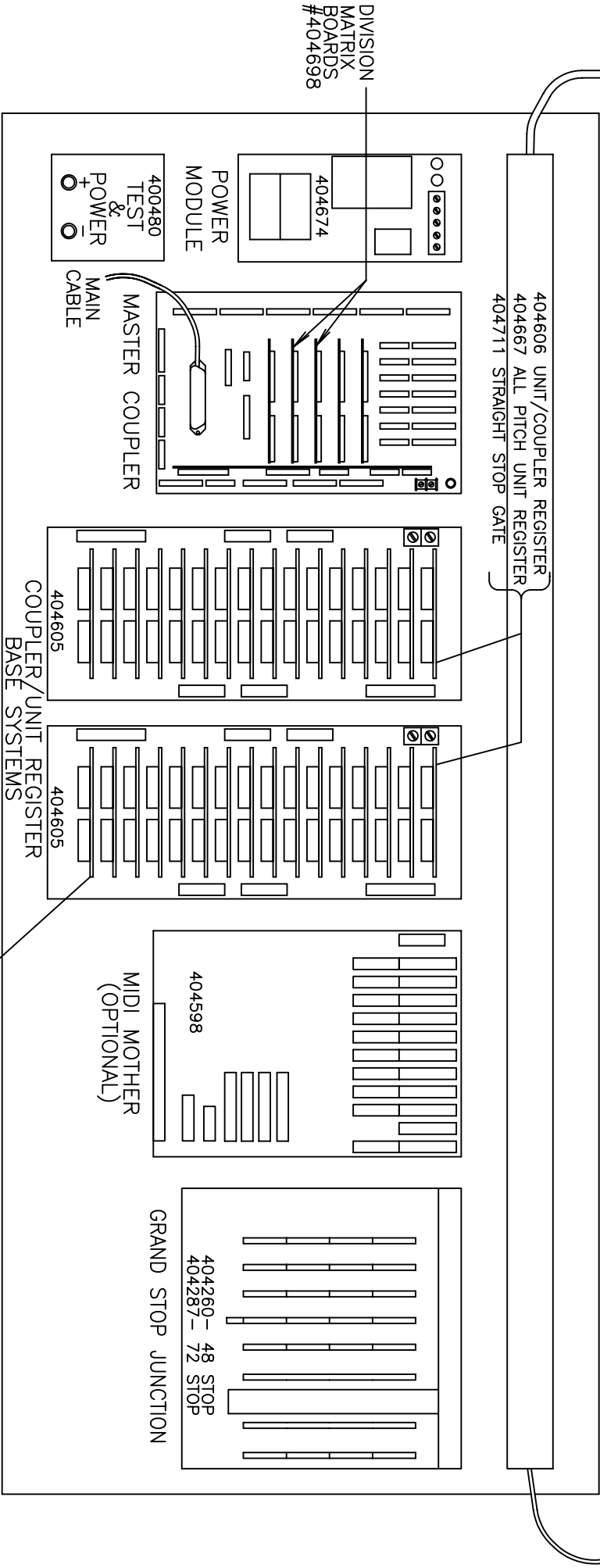

FIGURE 1
MASTER COUPLER SYSTEM

CLASS II TRANSFORMER
OR CONSOLE AC CONTROL SYSTEM

STOP CABLE TO COMBINATION ACTION

MULTIPLEXING (CONSOLE) PANEL

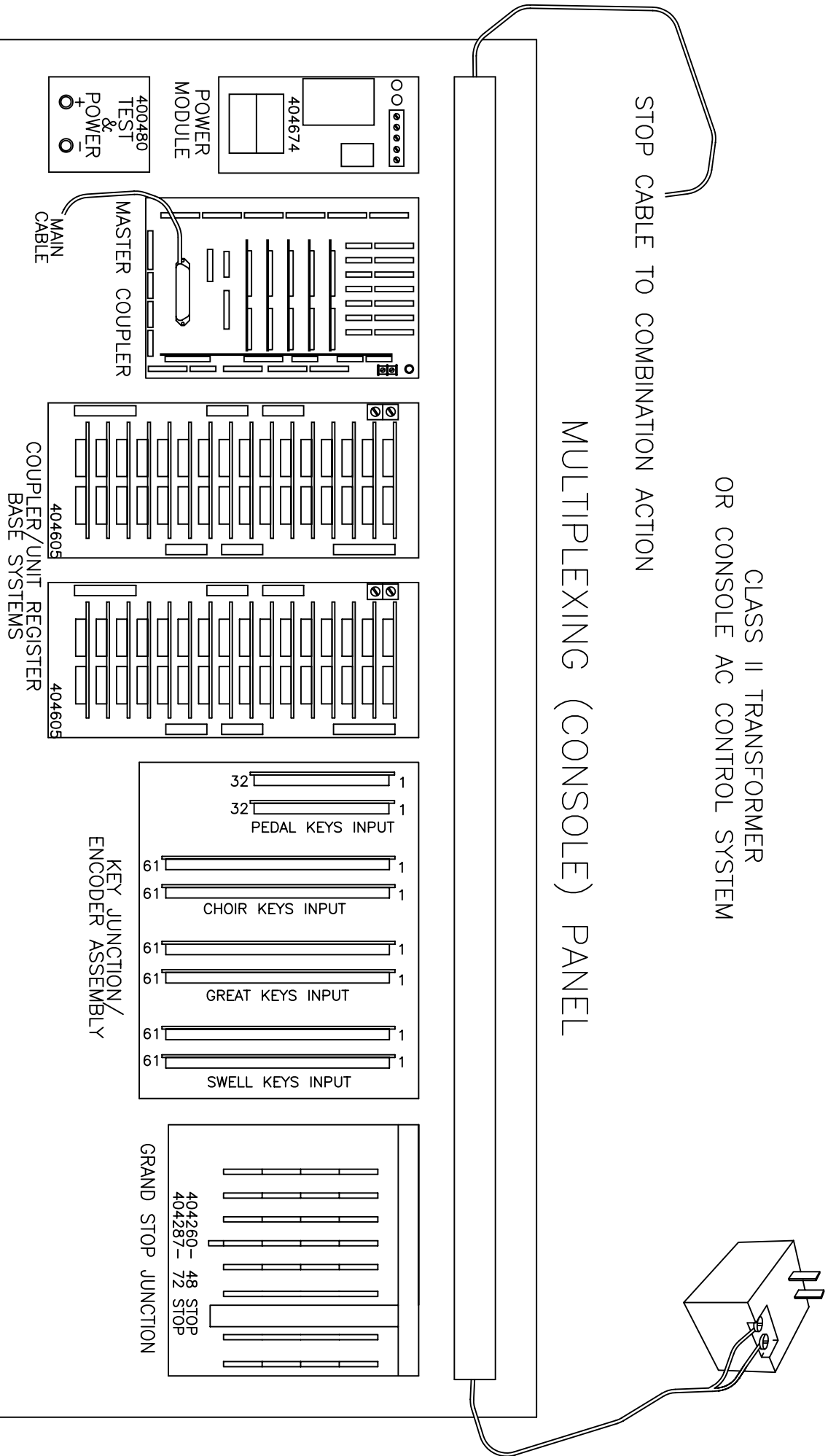

FIGURE 2
DC KEYED MASTER COUPLER SYSTEM

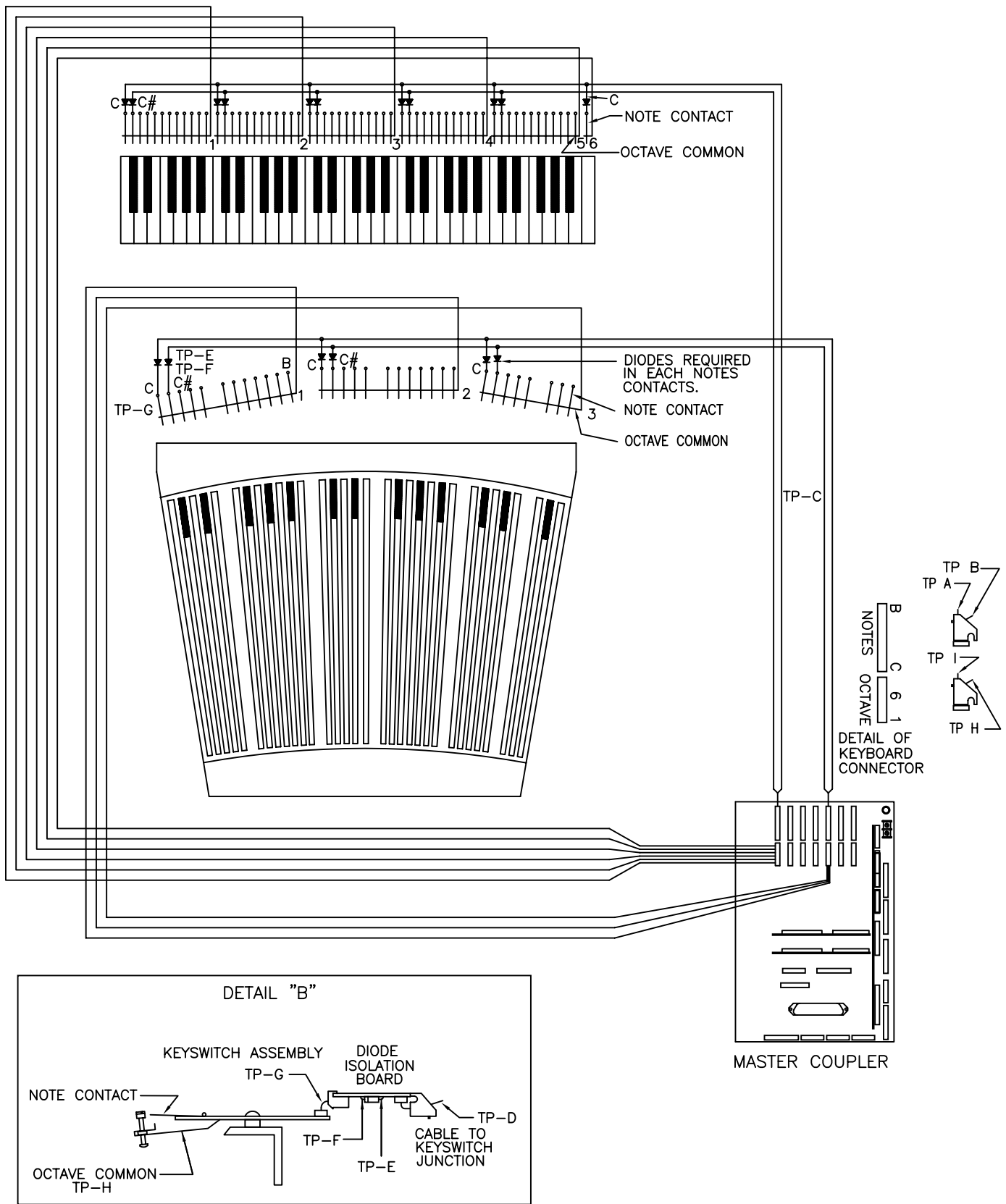
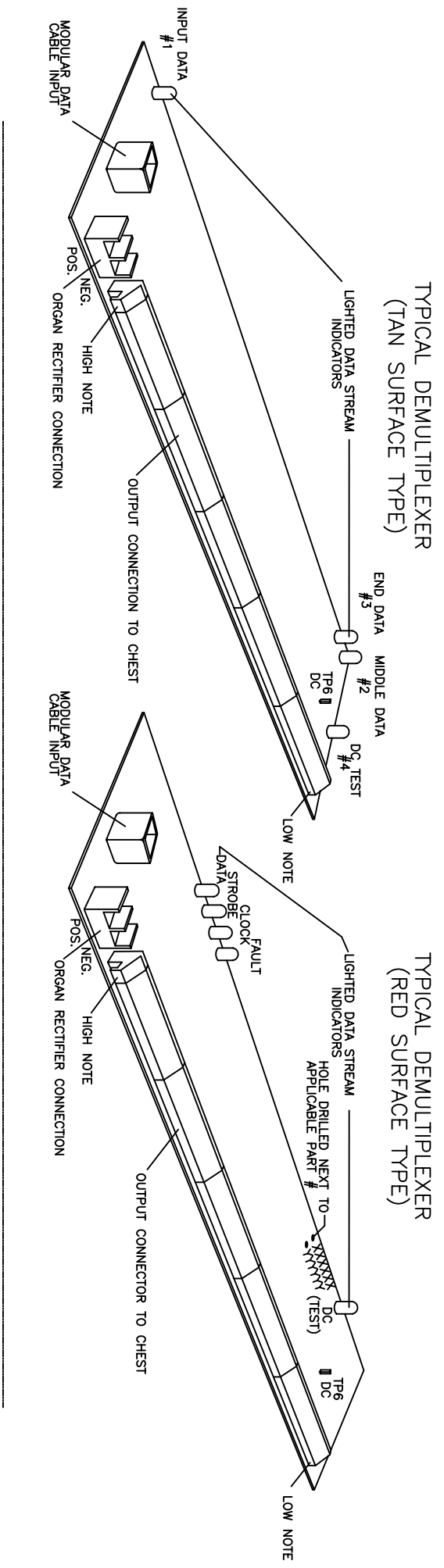

FIGURE 3

KEYBOARD WIRING FOR THE
MASTER COUPLER SYSTEM



TYPICAL DEMULTIPLEXER (TAN SURFACE TYPE)

TYPICAL DEMULTIPLEXER (RED SURFACE TYPE)

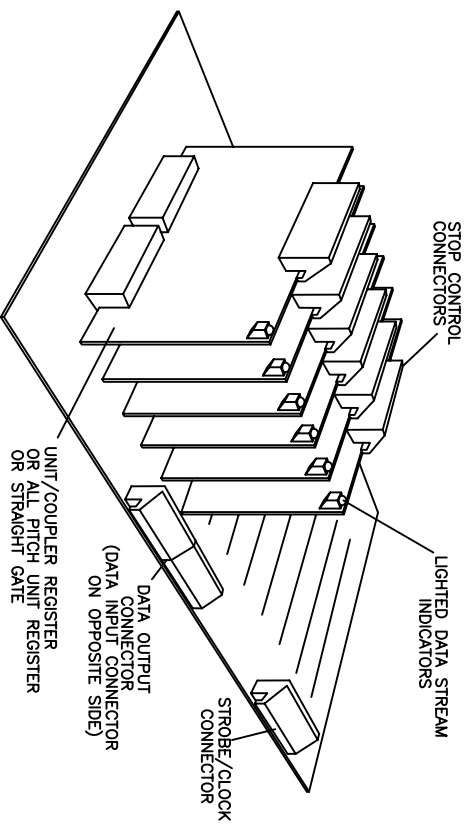
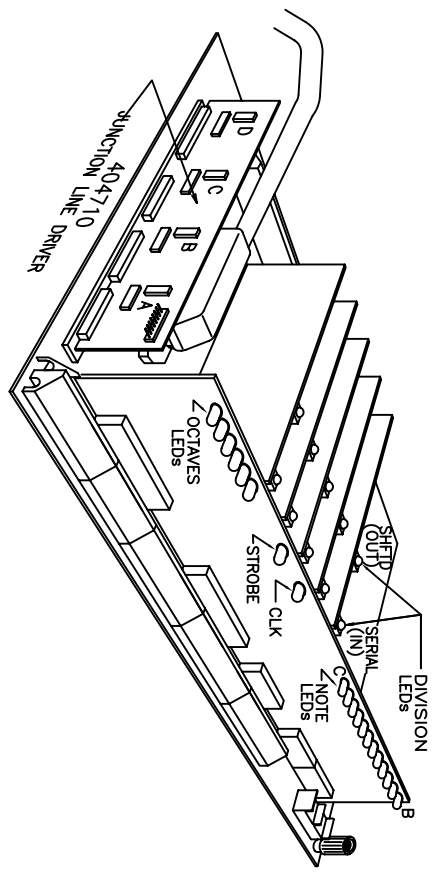

REVISIED 6-2000

FIGURE 4 "LIGHTED PATH INDICATORS"

190798

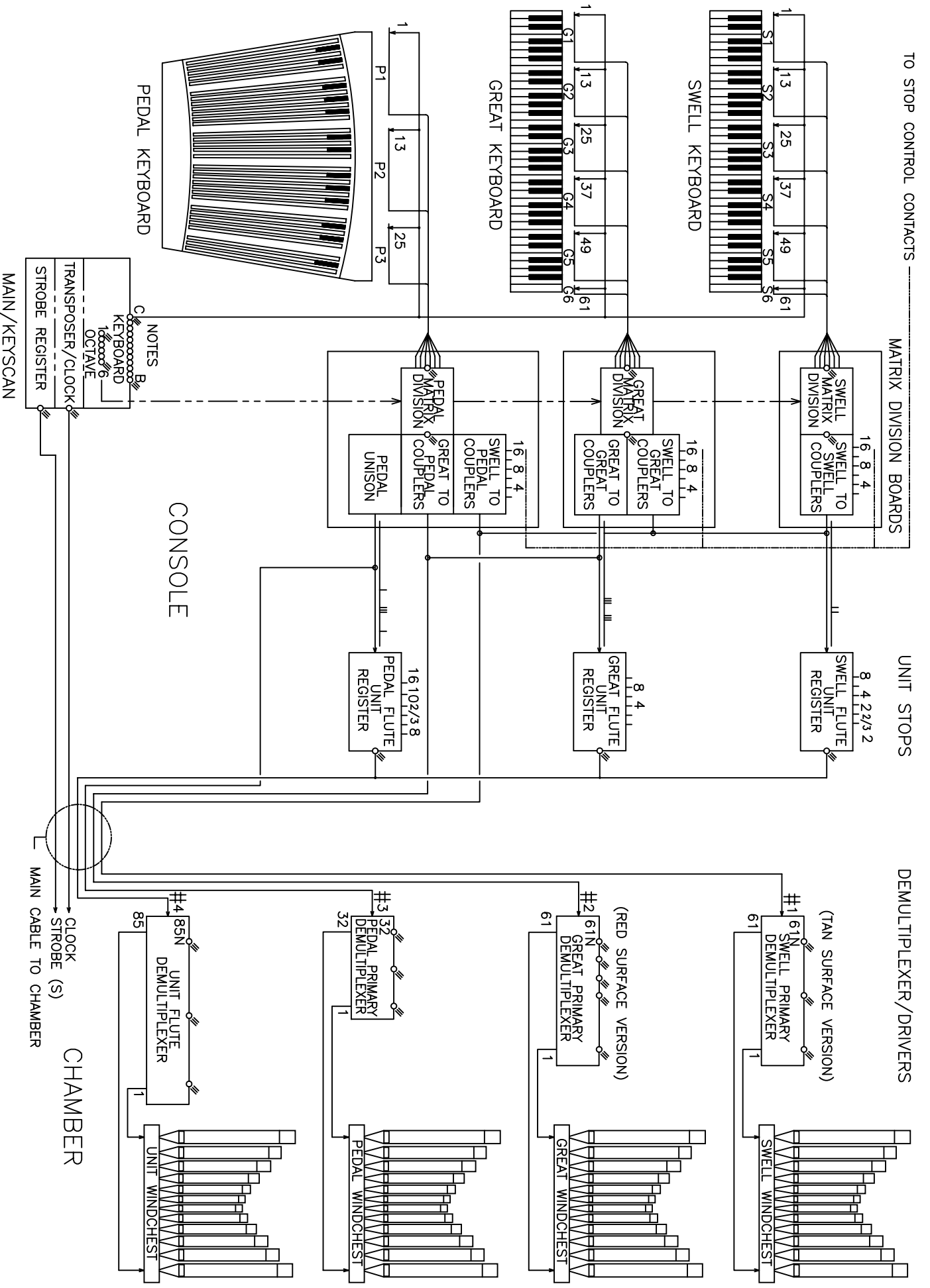
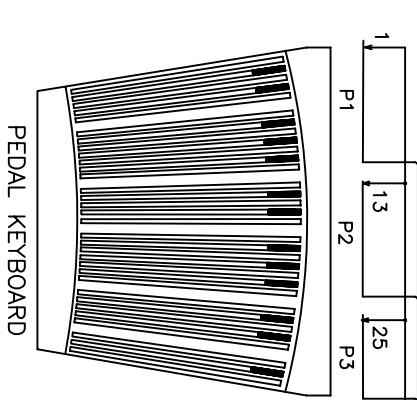
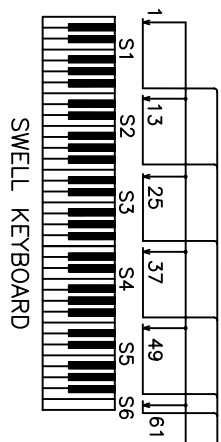
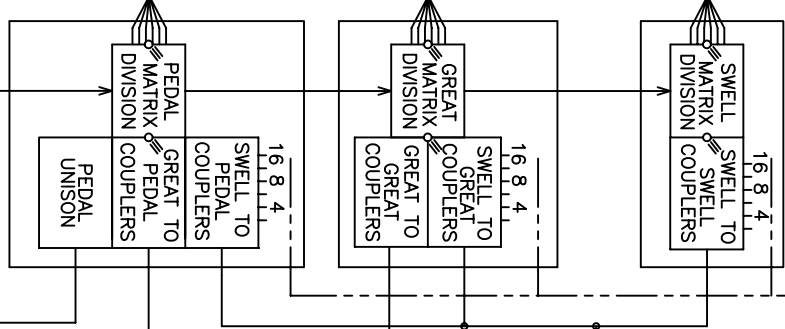

FIGURE 5
 MASTER COUPLER BLOCK DIAGRAM AND
 "LIGHTED PATH INDICATORS"

TO STOP CONTROL CONTACTS



MATRIX DIVISION BOARDS



DIVISION ALL-PITCH BOARDS

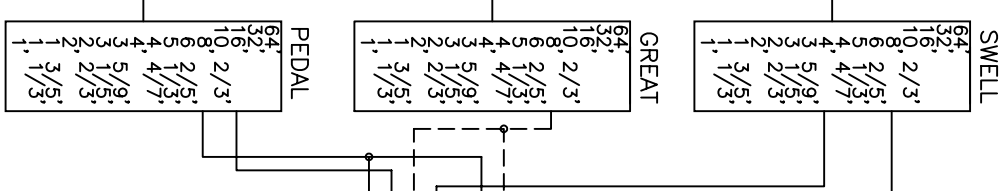

STRAIGHT GATES

INPUT	STOP JUNC.	STOP NAME	OUTPUT DATA
1 SW 8'		SWELL PRIMARY	
2 GT 8'		GREAT PRIMARY	
3 PD 8'		PEDAL PRIMARY	
4 SW 4'		SWELL 4' FLUTE	
6 GT 8'		GREAT 8' FLUTE	
7 PD 16'		PEDAL 16' FLUTE	
8 PD 8'		PEDAL 8' FLUTE	

DEMULTIPLEXER/DRIVERS

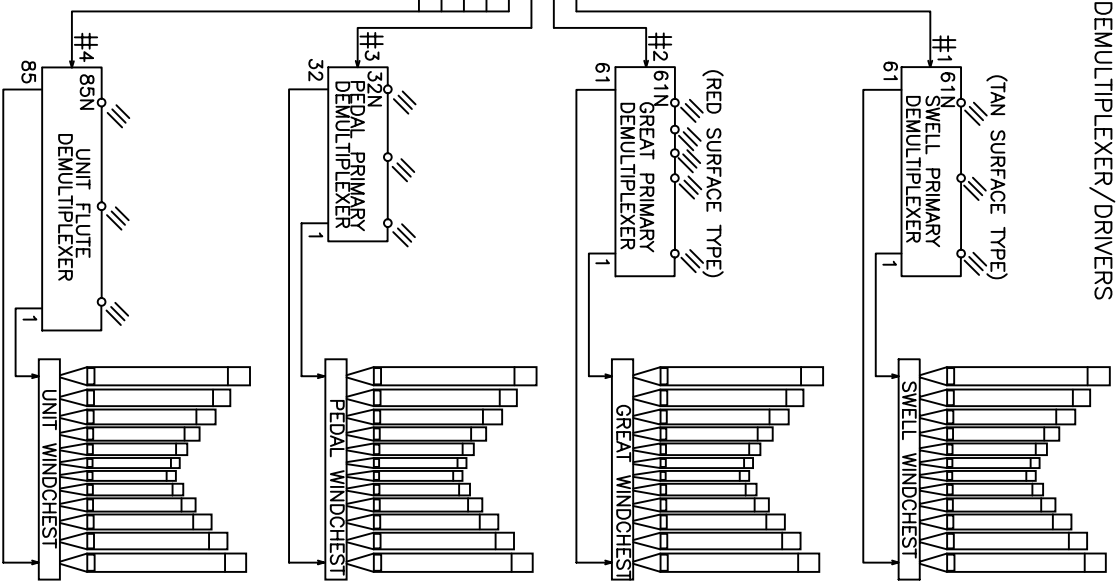

CONSOLE

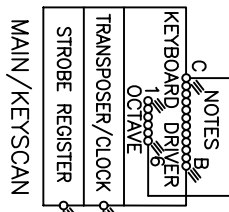

CHAMBER

☞ LIGHTED PATH INDICATORS

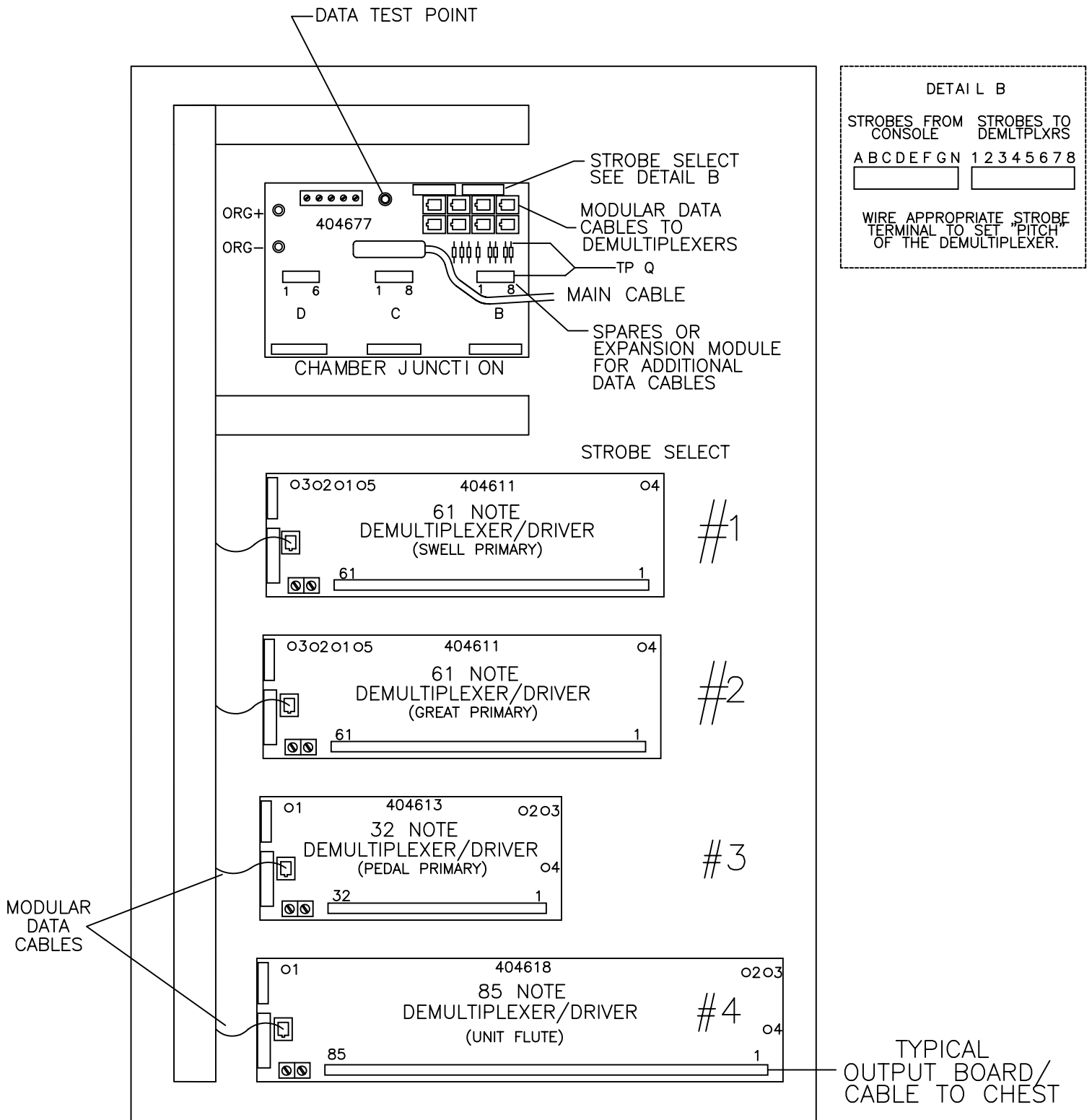

FIGURE 7
DEMULTIPLEXING (CHAMBER) PANEL

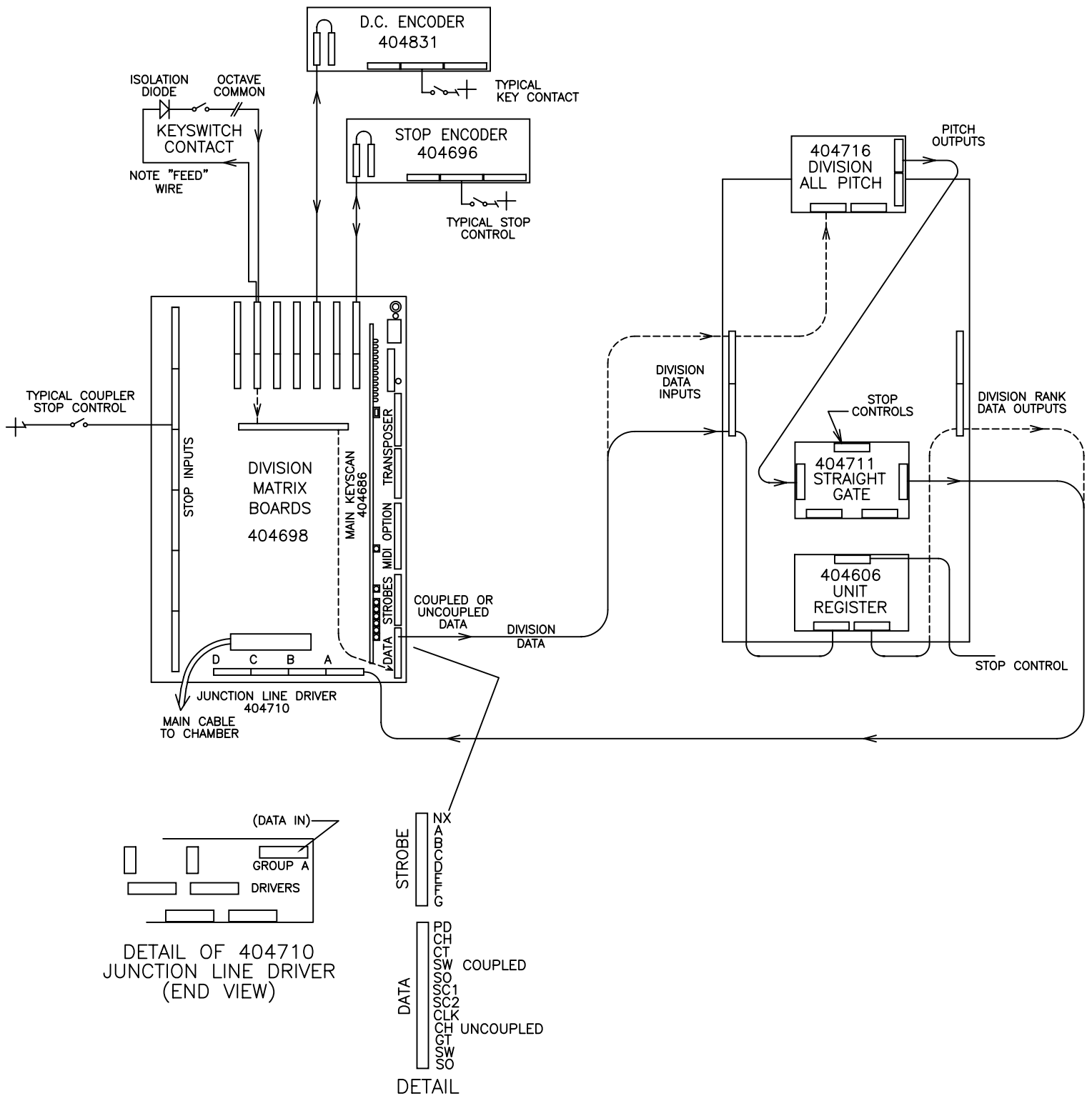

FIGURE 8
BASIC DATA / SIGNAL
PATHS IN CONSOLE

CHAMBER JUNCTION
404677

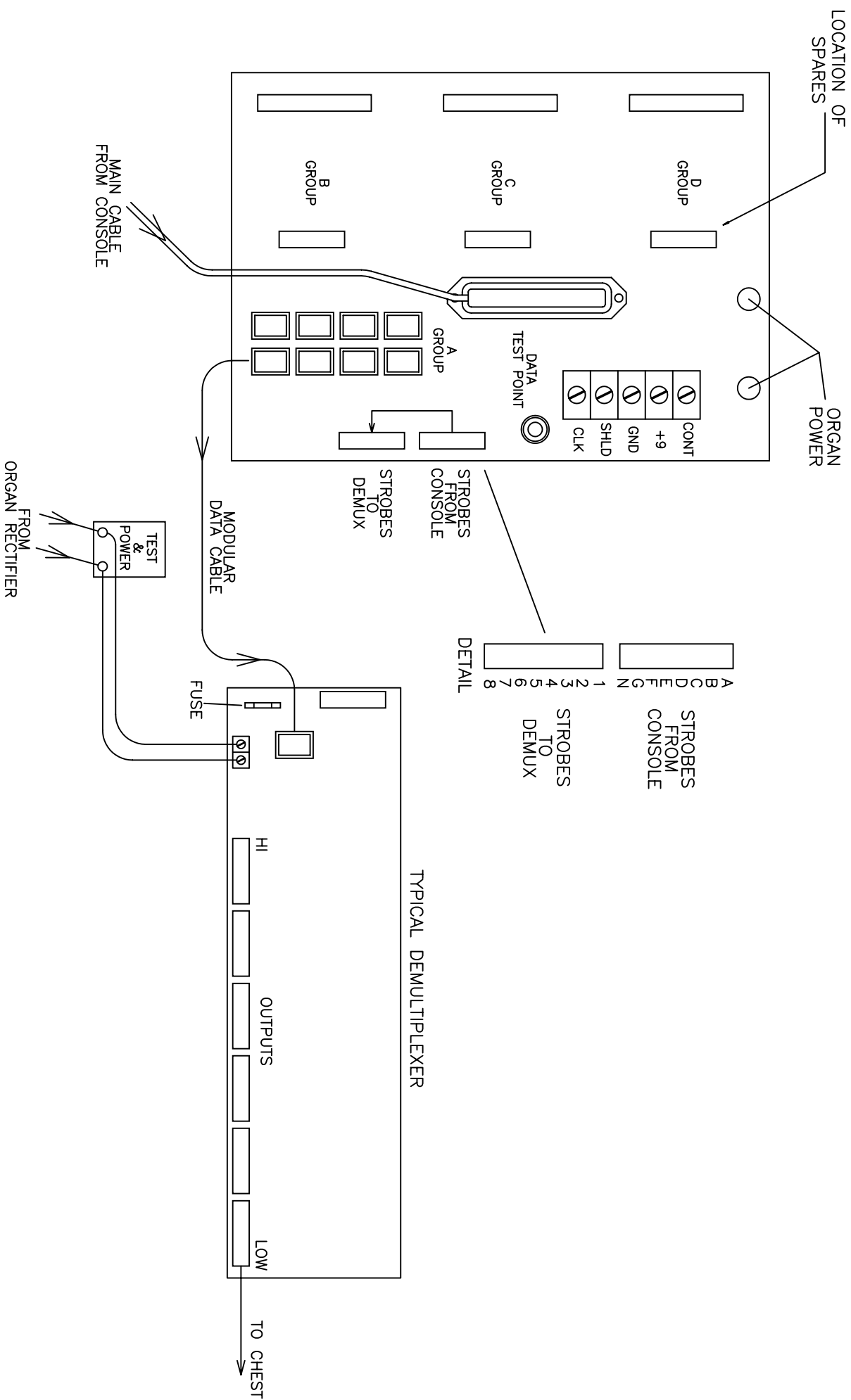
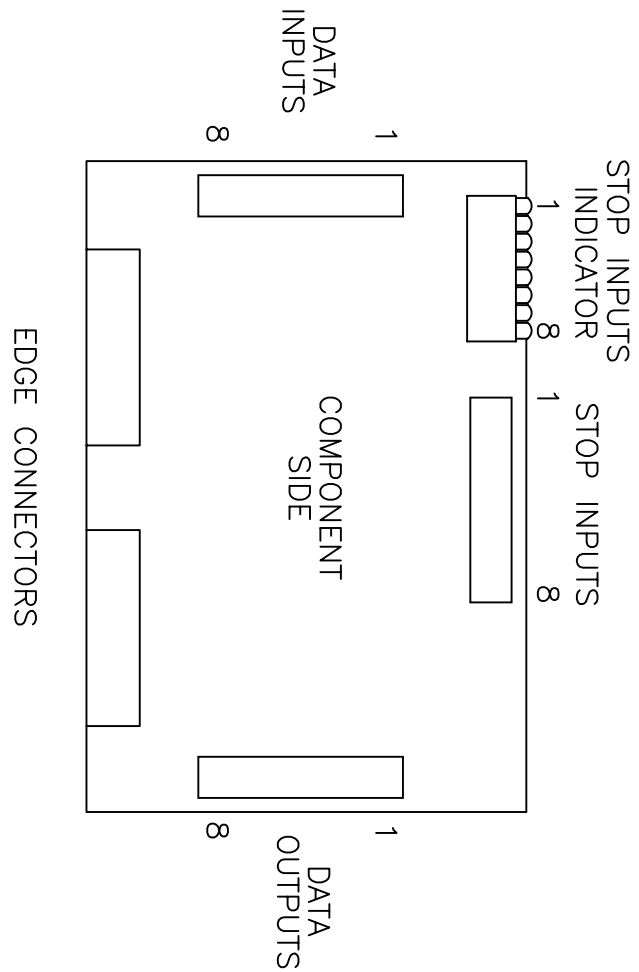

FIGURE 9

BASIC DATA / SIGNAL
PATHS IN CHAMBER

DETAIL A
STRAIGHT GATE
#404711



DETAIL B
DIVISION ALL PITCH
#404716

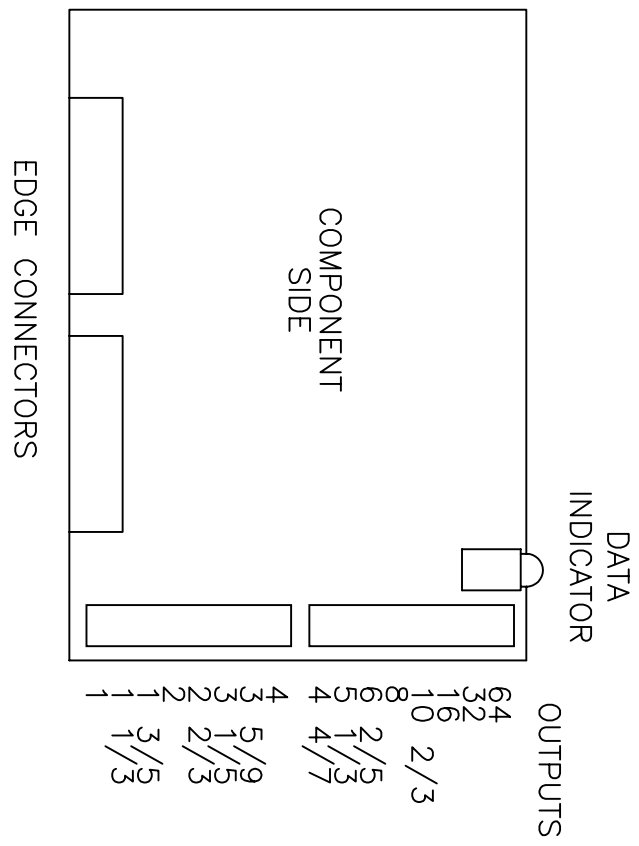

FIGURE 10

PROGRAM JUMPER PLACEMENT PEDAL DIVISION ONLY			
	PJ3	UO	PC
"NORMAL USE" (OR MANUAL DIVISIONS)	IN	OUT	OUT
PED UNISON OFF	OUT	IN	EITHER
OTHER PEDAL COUPLERS	OUT	EITHER	IN

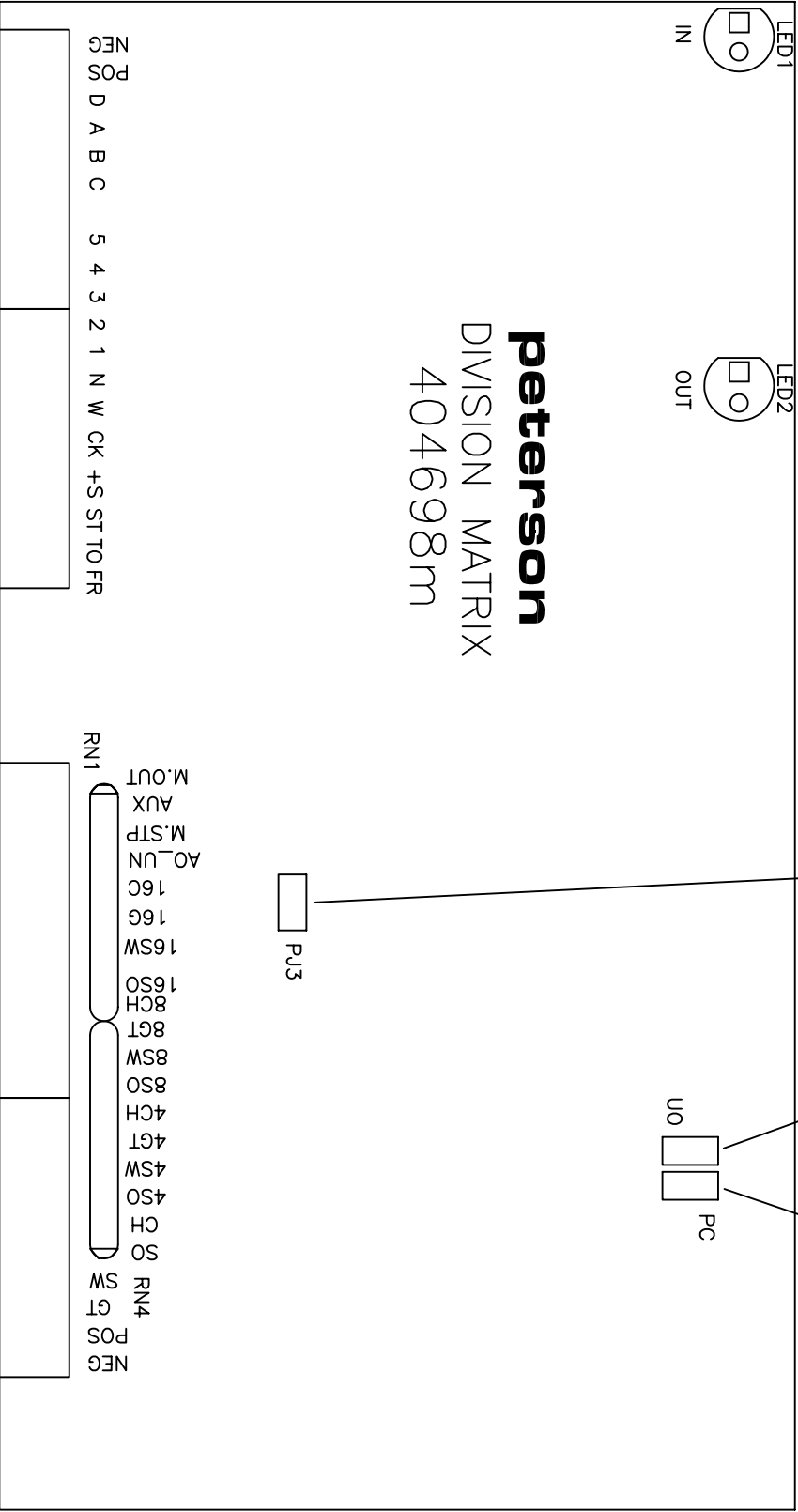
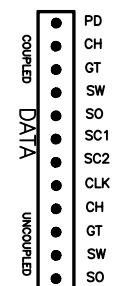
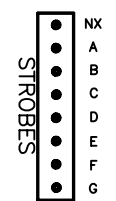
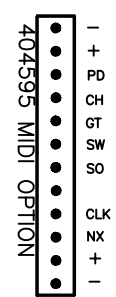
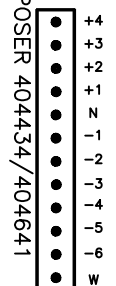
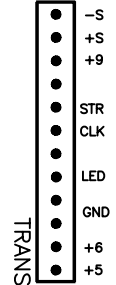
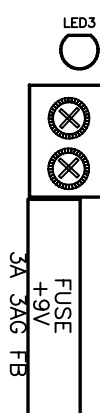
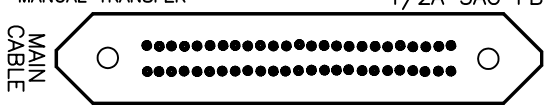
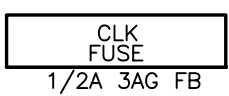
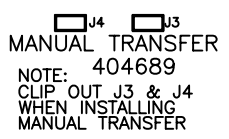
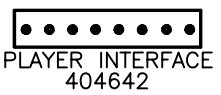
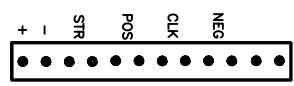
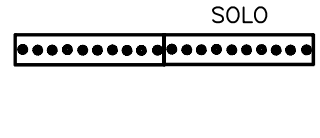
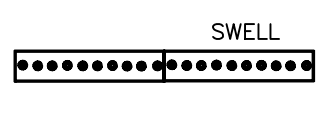
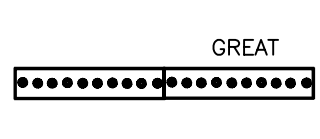
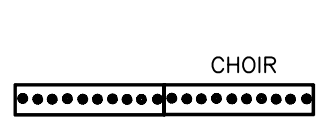
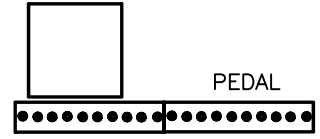
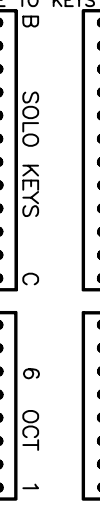
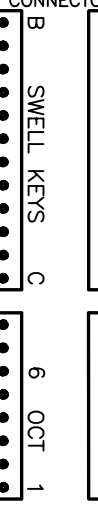
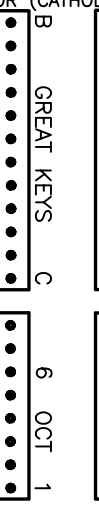
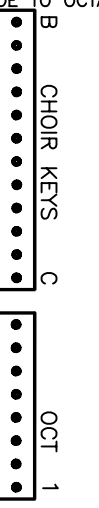
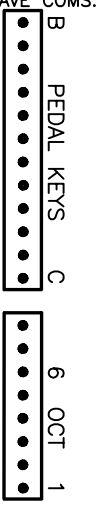
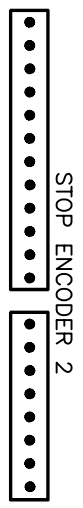
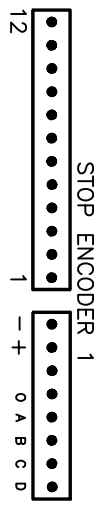

FIGURE 11
DIVISION MATRIX (VERSION "J" OR LATER)

TEST LIGHT NEG 9V POS



MAIN/KEYSCAN 404686



MAIN CABLE SPARES - JUNCTION LINE DRIVER 404710

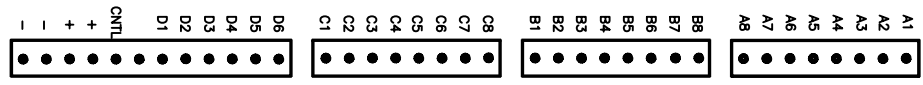

peterson ORGAPLEX™ MASTER COUPLER
MADE IN U.S.A. MOTHER BOARD ASSEMBLY 404697F

ALL MIDI COUPLERS ARE ENABLED WHEN PIN 72 IS CONNECTED TO ORGAN +

NOTE: DIODE ISOLATION MUST BE USED ON ALL 61 (32) KEY LINES ANODE TO KEYS CONNECTOR (CATHODE TO OCTAVE COMS.)

WARNING: DO NOT APPLY ORGAN POSITIVE DIRECTLY TO ABOVE CONNECTORS

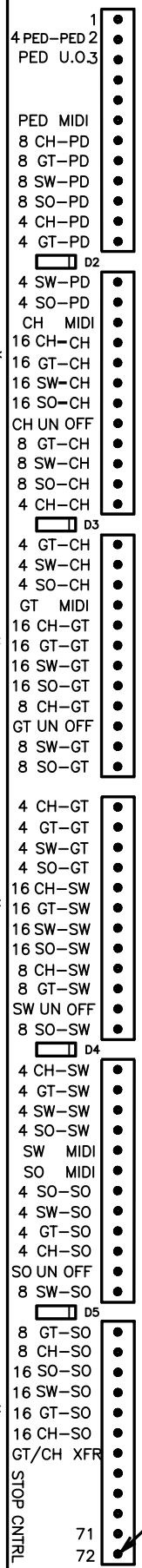

NOTE: INPUT PINS LABELED WITH "*" BECOME 8' PEDAL TO XX WHEN PROGRAM JUMPERS J1,J2,J5 OR J6 ARE IN PLACE.

FIGURE 12 ORGAPLEX MASTER COUPLER MOTHER BOARD (VERSION F OR LATER)